

**EXPERT REPAIRS  
ON ALL TOOLS**

# CHERRYMAX® RIVETERS

**REBUILTS  
AVAILABLE**

This new compact power riveter weighs only 3.625 pounds, yet has the power of much larger and heavier tools. The G747 riveter installs -4, -5, and -6 CherryMAX® rivets in all grips and materials. The lightweight and compact ergonomic design greatly reduces operator fatigue. The angled pulling head allows installing rivets using a natural hand position for optimum comfort. This tool can be operated in any position with one hand, and offers a choice of straight, right angle, and offset pulling heads. **STROKE: .437 PULLING CAPACITY: 2,100 lb. @ 90 psi.**

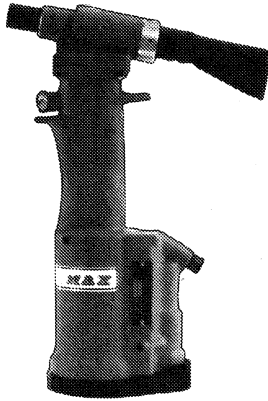

**G747 POWER RIVETER**

CherryMAX® Power Tool  
**National Stock Number: 5130-01-393-1584**  
**Military Part Number: M85188T2**

**DESCRIPTION**

The Cherry G704B is a pneumatic-hydraulic tool designed specifically for the most efficient installation of CherryMAX® rivets. Its durable, all metal housing makes this extremely robust tool ideal for use in rugged shop environments. This tool utilizes straight, offset and right-angle pulling heads, all of which can install -4, -5, and -6 diameter CherryMAX® bulb type rivets in all head styles, materials and grip lengths. Extensions are available for extending the pulling heads to reach limited access areas. See the section on pulling heads for the correct pulling head part number. **Weight: 4-1/4 pounds.**

**PULLING FORCE: 3100 Pounds (13.79kn) @ 90 PSI (6.2 bar)**

**G704B**

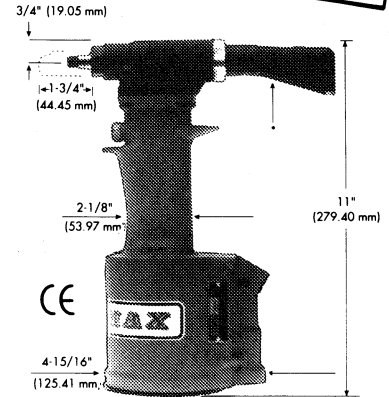

**G747 & G704B Pulling Head Selection Chart**

Pulling Head	Type	Adapter	Rivet	Rivet Diameters	Maximum Grip <sup>1</sup>
H701B-456	Straight	-	CherryMAX CherryMAX "AB" InterMAX SST	1/8, 5/32, 3/16 <sup>2</sup> 1/8, 5/32, 3/16 <sup>3</sup> 1/8, 5/32, 3/16 1/8, 5/32, 3/16 <sup>2</sup>	All -4 <sup>1</sup> -4 <sup>1</sup> All
H747-3NPR	Straight	-	Nut-plate	3/32	-4 <sup>1</sup>
H753A-456	Right Angle	-	CherryMAX CherryMAX "AB" InterMAX SST	1/8, 5/32, 3/16 <sup>2</sup> 1/8, 5/32, 3/16 <sup>3</sup> 1/8, 5/32, 3/16 1/8, 5/32, 3/16 <sup>2</sup>	All -4 <sup>1</sup> -4 <sup>1</sup> All
H781-456	Offset	-	CherryMAX CherryMAX "AB" InterMAX SST	1/8, 5/32, 3/16 <sup>2</sup> 1/8, 5/32, 3/16 <sup>3</sup> 1/8, 5/32, 3/16 1/8, 5/32, 3/16 <sup>2</sup>	All -4 <sup>1</sup> -4 <sup>1</sup> All
H9015	Straight	704A9	MS <sup>4</sup>	3/32, 1/8, 5/32, 3/16	-4 <sup>1</sup>
H955	Straight	-	CherryLOCK "A"	3/32, 1/8, 5/32, 3/16	-4 <sup>1</sup>

1. On the first stroke. 2. Nominal and oversize. 3. No 3/16 aluminum, Stainless steel and Monel only. 4. Serrated stems only.

**G747 & G704B PULLING HEADS**

Pulling Heads are not furnished with riveter and must be ordered separately.

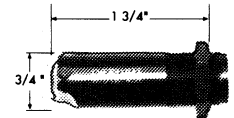

**H701B-456 Straight**  
**NSN5130-01-393-2927**  
**Military Part Number M85188S1**

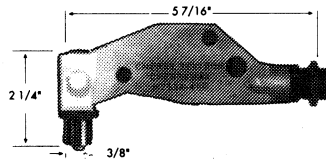

**H753A-456 Right Angle**  
**NSN5130-01-393-2926**  
**Military Part Number M85188S2**

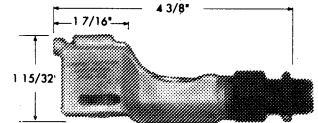

**H781-456 Offset**  
**NSN 5130-01-393-2925**  
**Military Part Number M85188S3**

**G704B-SR**  
**3/16 CAP.**

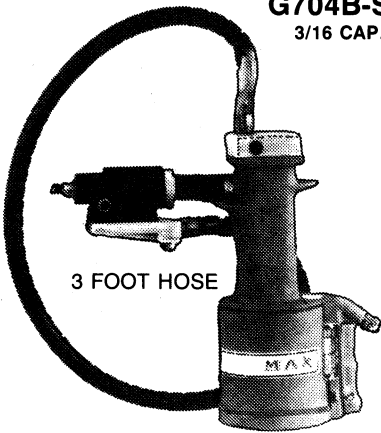

**3 FOOT HOSE**

**G704BCMR**

The G704BCMR Power Riveter Kit contains the following items:

- 1 Ea. G704B Power Riveter
- 1 Ea. H701B-456 Straight Pulling Head
- 1 Ea. 700A77 Air Bleeder
- 1 Ea. 269C3e Selector Gauge
- 1 Ea. 670A20 Stem Catcher Bag
- 1 Ea. P1258 Metal Carrying Case
- 1 Ea. G704B Power Riveter Manual
- 1 Ea. H701B-456 Pulling Head Sheet
- 1 Ea. CherryMAX Process Manual
- 1 Ea. CherryMAX Pocket Card



**G-27 HAND RIVETER**

The Cherry G-27 Hand Riveter is designed specifically for the most efficient installation of 1/8" CherryMAX Rivets. Overall length of the G-27 is 9-1/4", the net weight is just 13 ounces and the pulling head is an integral part of the tool. This compact, lightweight tool comes in a rugged plastic case.

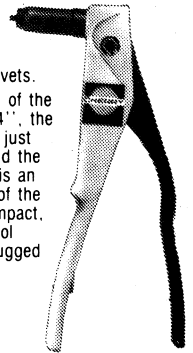

**G750A HAND RIVETER**

The Cherry hand hydraulic riveting tool provides the versatility of a pneumatic-hydraulic riveter, but with the lightweight, high pull strength ratio desirability not found in other hand riveters. The Cherry G750 has a unique 2-step hydraulic power cylinder that provides the user with the ease of pulling the handle without the strain normally endured to install a high strength fastener. This patentable 2-step power feature allows the user to squeeze the handle throughout the increase power requirement, without feeling the need to squeeze harder to install the fastener.

The Cherry G750 hand riveter can install a variety of blind fastener styles, diameters, head configurations, and material combinations without changing the pulling head or adjusting the tool.

The Cherry G750 hand hydraulic riveter comes in a sturdy plastic carrying case as shown and can be ordered by the following Kit Number:

Kit No.	Adapter No.	Offset Pulling Head	Right Angle Pulling Head
G750A	NA	NA	NA
G750ACMR	750-050	H781-456	H753A-456

