

ABRASIVE POWER TOOLS



DYNAFILE®
VERSATILE ABRASIVE BELT SANDER

11000
 AIR POWERED
 BELT SANDER ONLY..

◀ **VERSATILITY KITS** .. 11001...
 Include 5 different contact arms, 11000 BELT SANDER AND ABRASIVE BELTS

FEATURES



Grind radius with belt over shaped contact wheel



Polish with unsupported part of belt

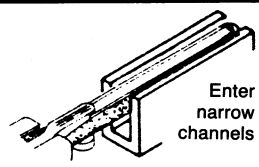

Enter narrow channels

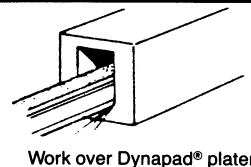

Work over Dynapad® platen

- Replaces tedious hand filing & sanding (4000 SFPM).
- Lightweight and easy to use.
- Superior belt tracking.
- Uses 1/8", 1/4" & 1/2" wide x 24" long belts.
- In addition to coated abrasive belts, non-woven nylon and cloth polishing belts may be used.
- Contact arms and belts changed easily without tools.

27 INTERCHANGEABLE ARMS FOR TOTAL GRINDING AND POLISHING VERSATILITY

MINI-DYNORBITAL® SANDER

Air tool uses fine grade discs for finesse sanding and defuzzing wood.

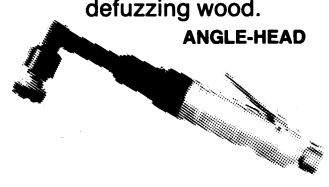

ANGLE-HEAD



PALM-STYLE

53400 3,200 RPM.
 Uses 3/4" and 1-1/4" discs

57500 5,000 RPM.
 Uses 3/4" and 1-1/4" discs.

TWO-HAND DYNORBITAL® SANDER

Long Handle Random Orbital Sanders
 Abrasive Capacity: 5" and 6" diameter discs.

Provides better reach and comfort, especially when sanding vertical sides.

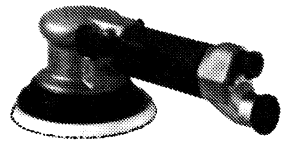

Non-Vacuum Models
 Model 57200 - 5" Diameter
 Model 57210 - 6" Diameter

Vac-Ready Models
 Model 57201 - 5" Diameter
 Model 57211 - 6" Diameter

- Provides excellent comfort and control, especially when working on vertical sides of workpiece. Long handle allows two-hand support of tool.

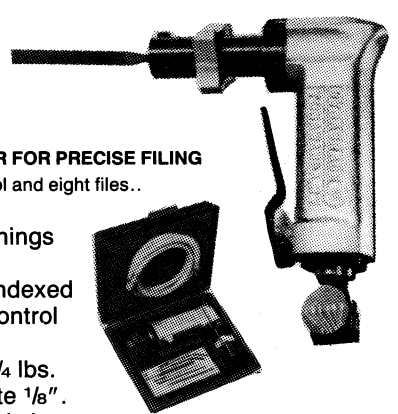

DYNAIDIE®
AIR-POWERED FILER FOR PRECISE FILING

- 12081 Kit includes tool and eight files..
- FEATURES**
- Enter tight openings down to 5/32".
 - Barrel can be indexed 360° for total control of file position.
 - Weighs only 1 3/4 lbs.
 - Files reciprocate 1/8".
 - 0-3,000 strokes/min.

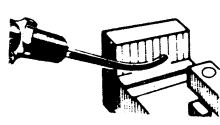

Uses 19 varieties of superior quality Swiss pattern files



DYNAFILE® II

- POWERFUL, LIGHTWEIGHT ABRASIVE BELT SANDER**
- Work on metal, wood, plastic, fiberglass, etc.
 - Eleven interchangeable contact arms.
 - Uses 1/4", 1/2" and 3/4" wide x 18" long belts.
 - Grinding head pivots to virtually any angle.

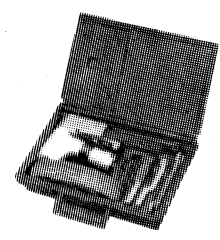
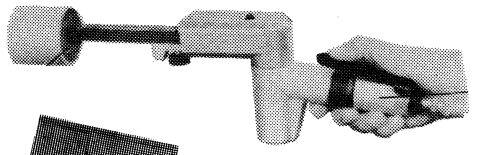

40321 VERSATILITY KIT...
 Kit includes 40320 Dynafile II, 3 different contact arms, abrasive belts, and 1/4" collet for converting motor to a die grinder.

LIGHTWEIGHT DYNORBITAL®

AIR-POWERED RANDOM ORBITAL SANDER FOR SWIRL-FREE FINISHING ON METAL, WOOD, PLASTIC AND FIBERGLASS

Non-Vacuum
 5" Model 57015
 6" Model 57026
 Low vibration; 10,000 RPM.

PALM-STYLE - WEIGHS ONLY 2.1 LBS.

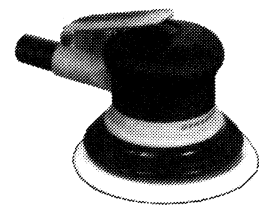

5" - 57016
6" - 57027

Easy one-hand control. Adjustable speed.

Vacuum-Ready models accept a self-contained dust collection system!